

TOYOTA CELICA Gr. B

Twin Cam Turbo

Winner :

Safari Rally 1984/1985/1986

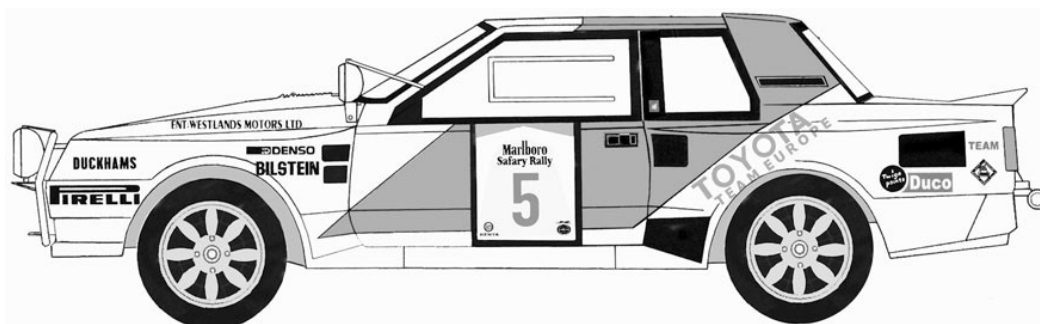

Profil 24-models

47 rue Julien Bodereau, 72000 Le Mans, France

www.profil24-models.com

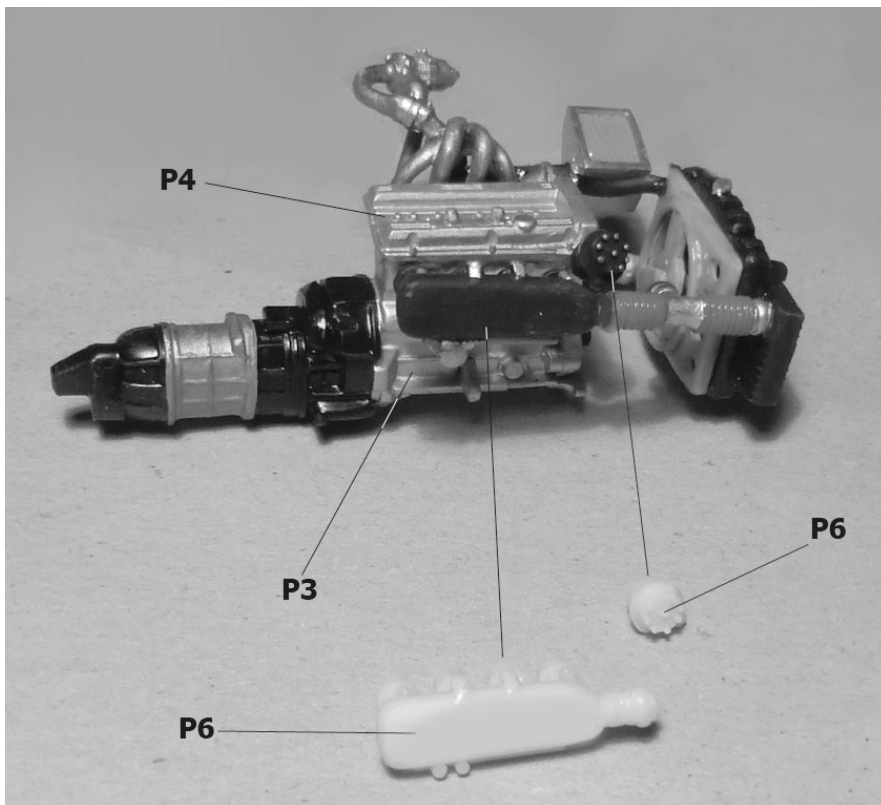
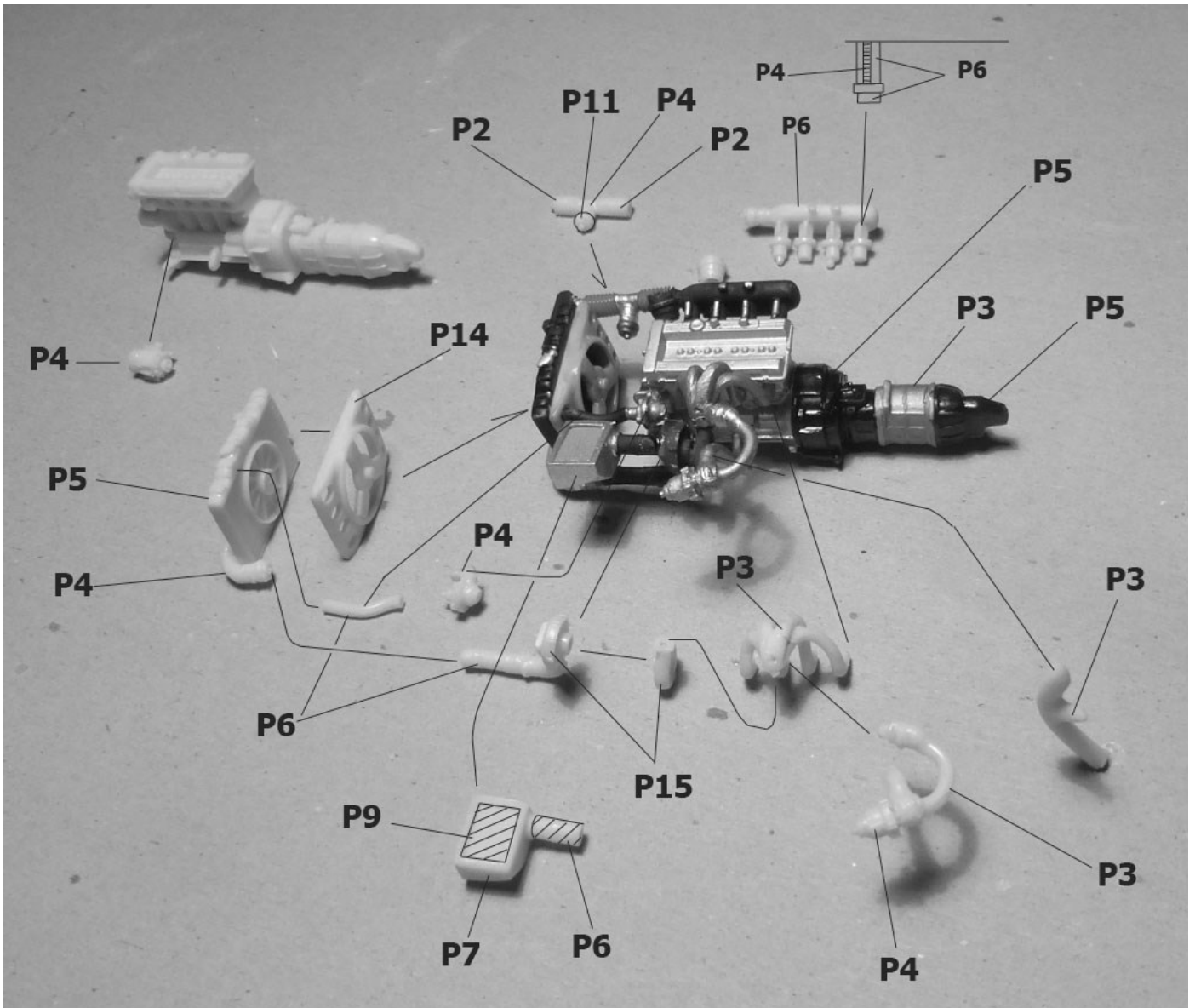

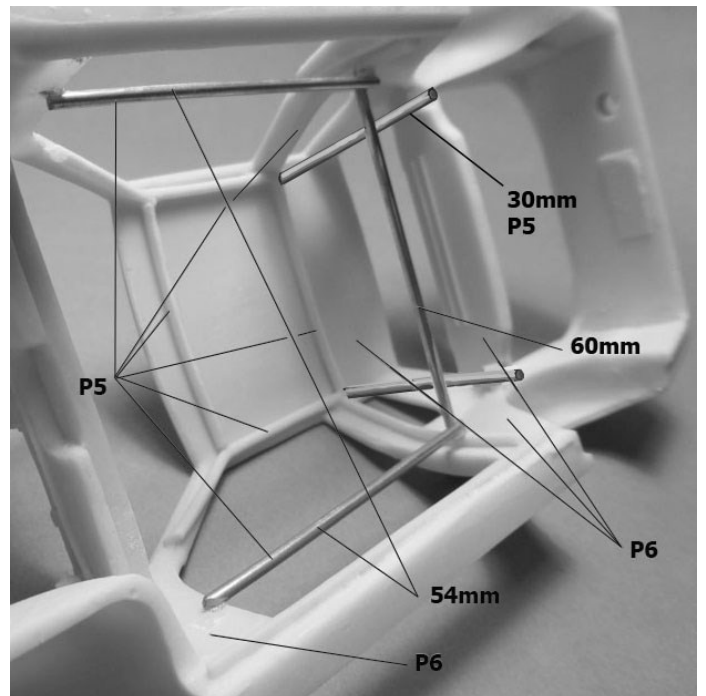
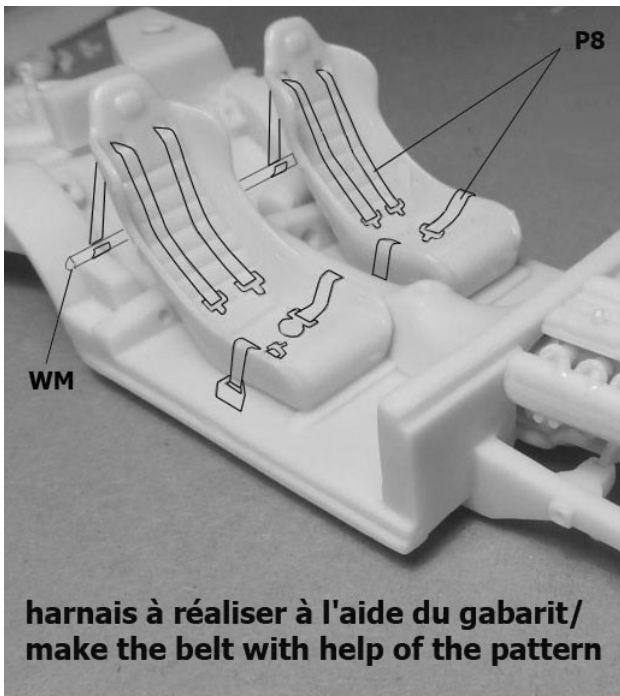
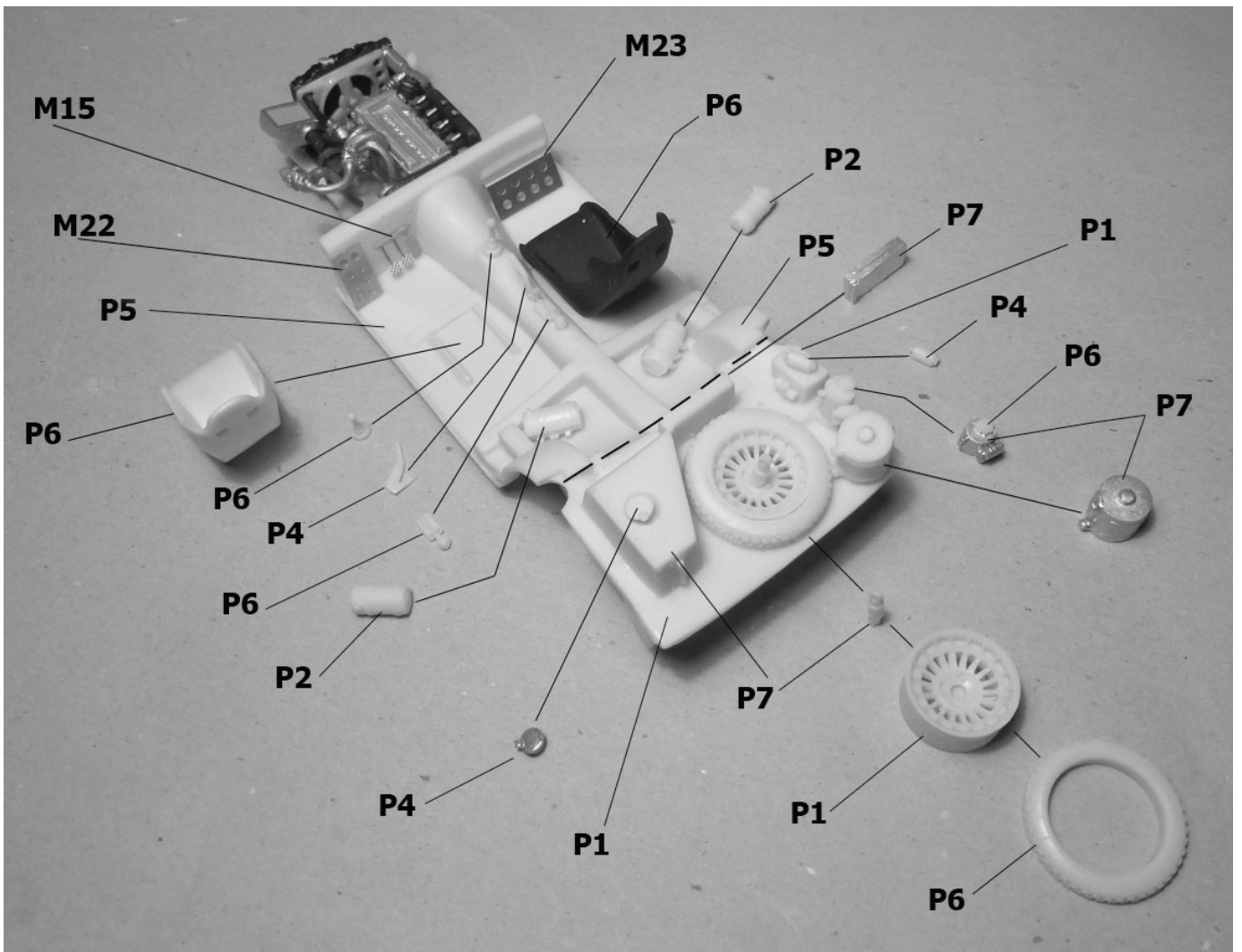

**Gabaris pour harnais /
Patterns for safety belts**

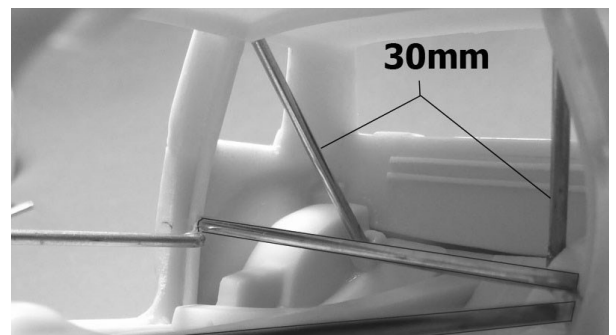
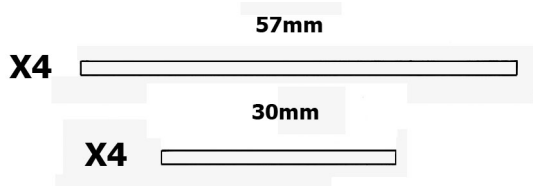

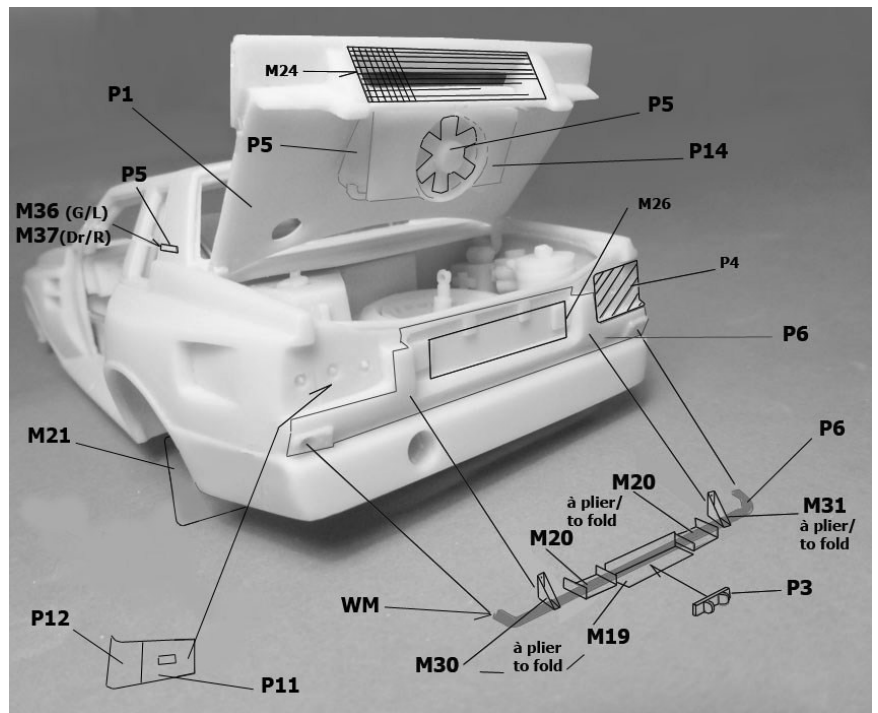
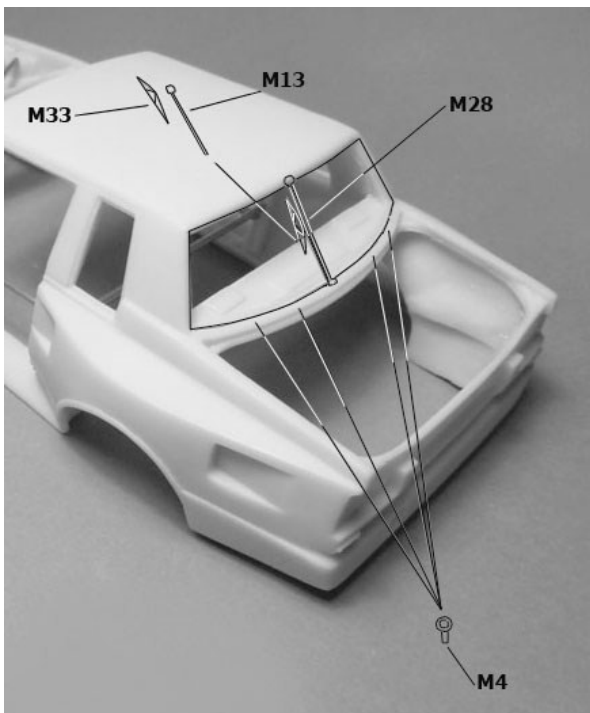
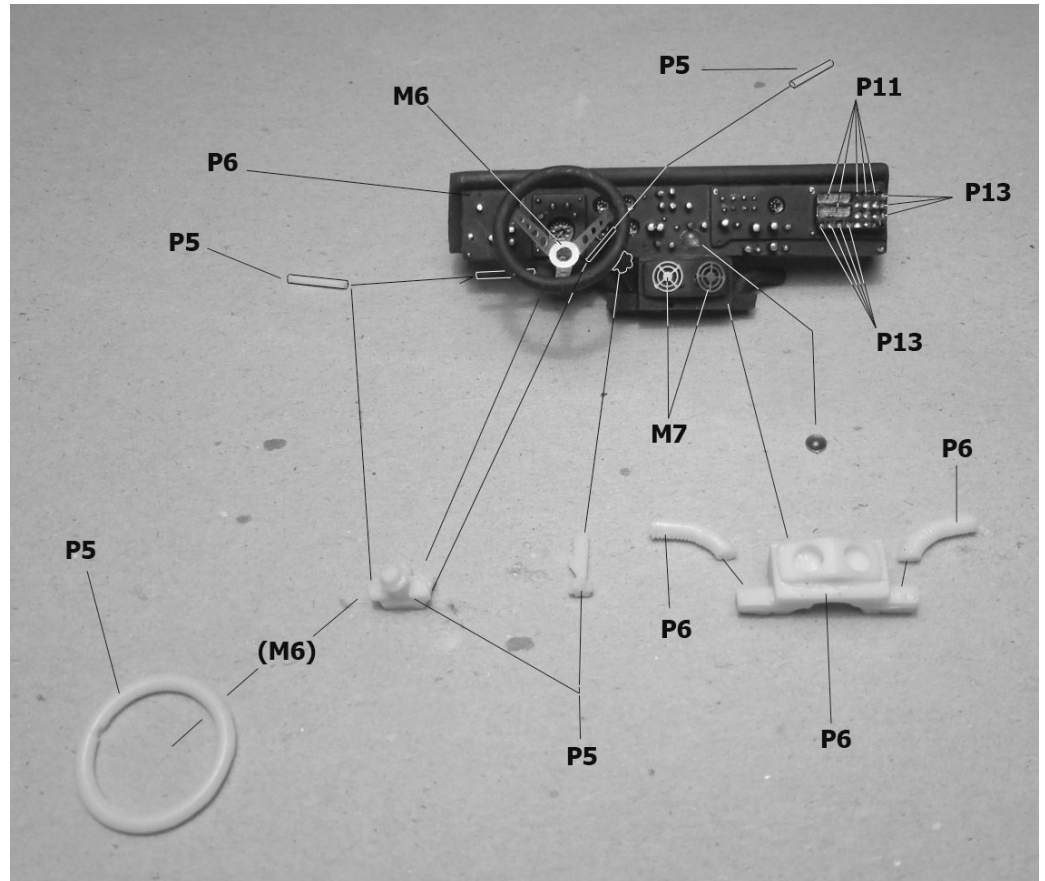
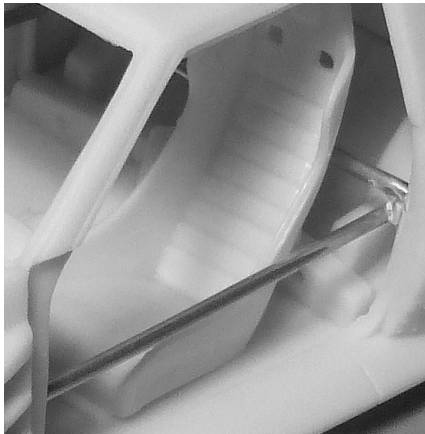
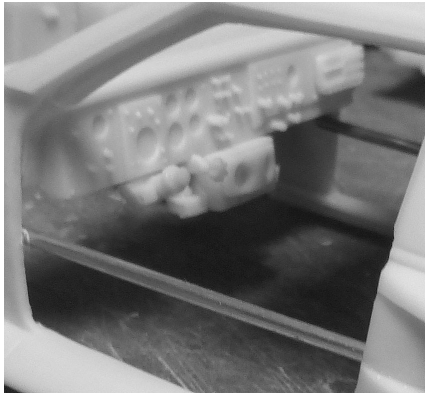

Peinture/ Paint

P1: Blanc / white

P2: Rouge / Red

P3: Cannon de fusil / Gun metal

P4: Argent / Silver

P5: Noir satiné / Satin black

P6: Noir mat / Flat black

P7: Chrome / Chrom

P8: Rouge mat / Flat red

P9: Beige / Beige

P10: Or / Gold

P11: Rouge vitrail / Stained red

P12: Orange vitrail / Stained orange

P13: Bleu vitrail / Stained blue

P14: Jaune vitrail / Stained yellow

P15: Métal brûlé / Burn metal

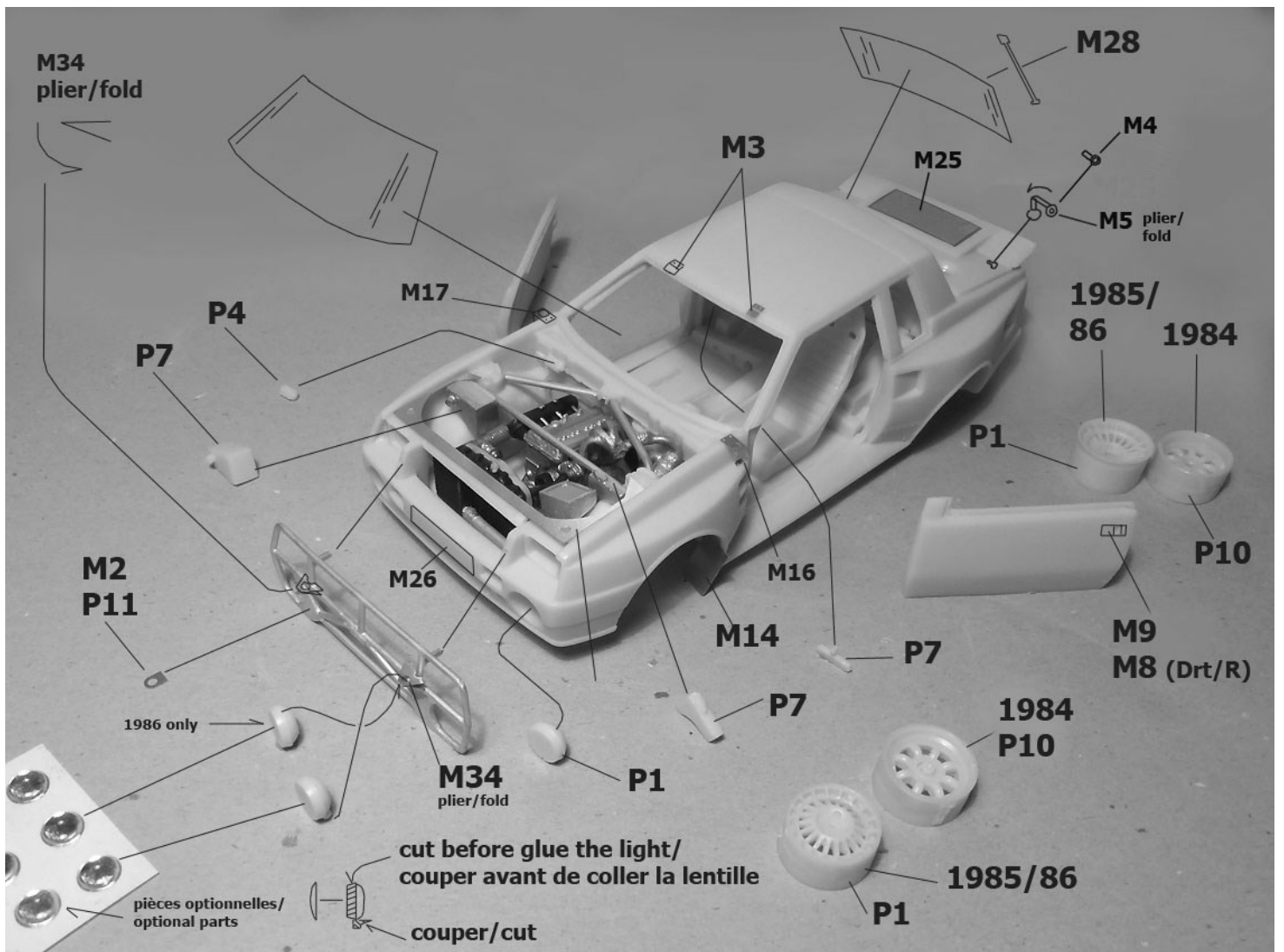
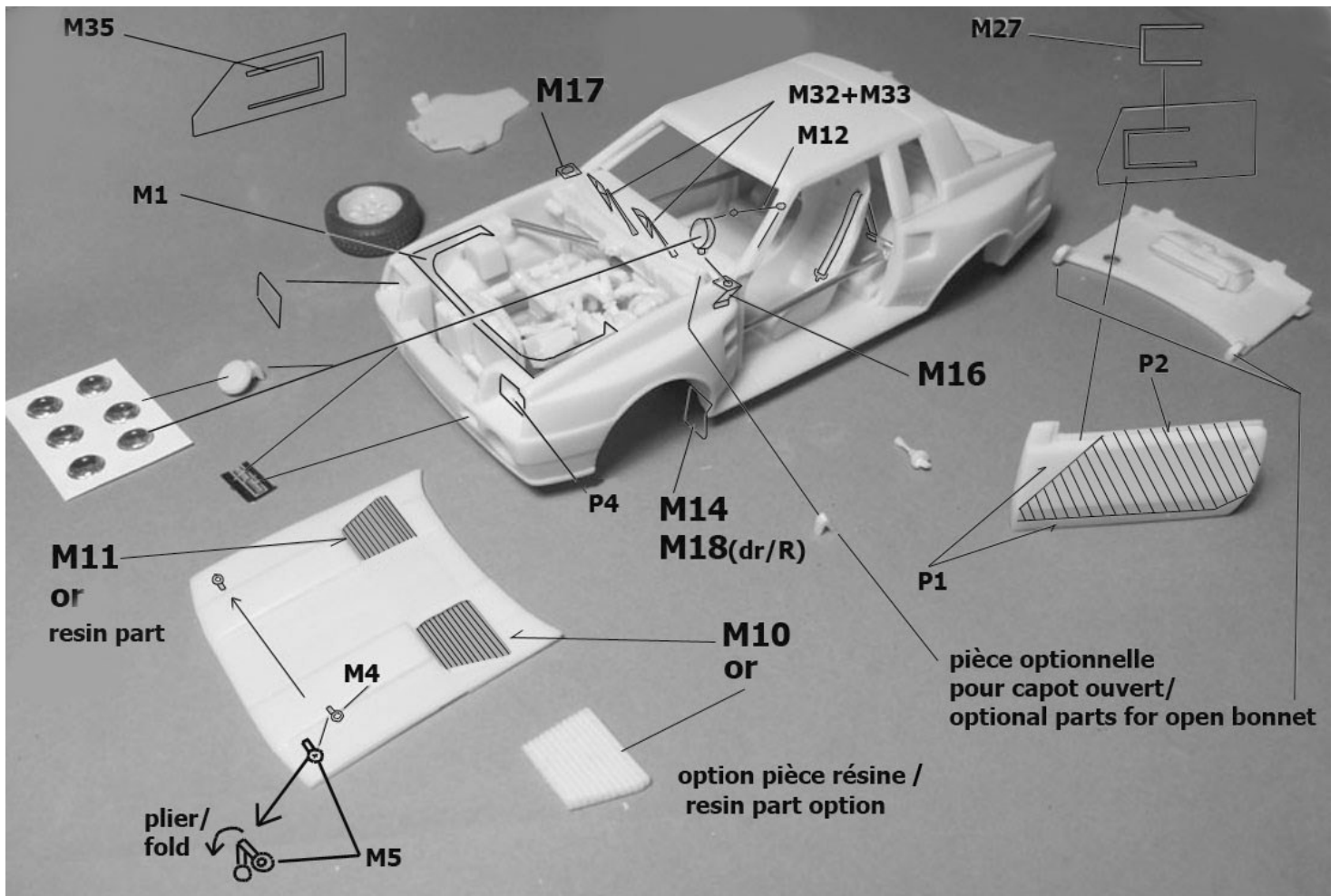

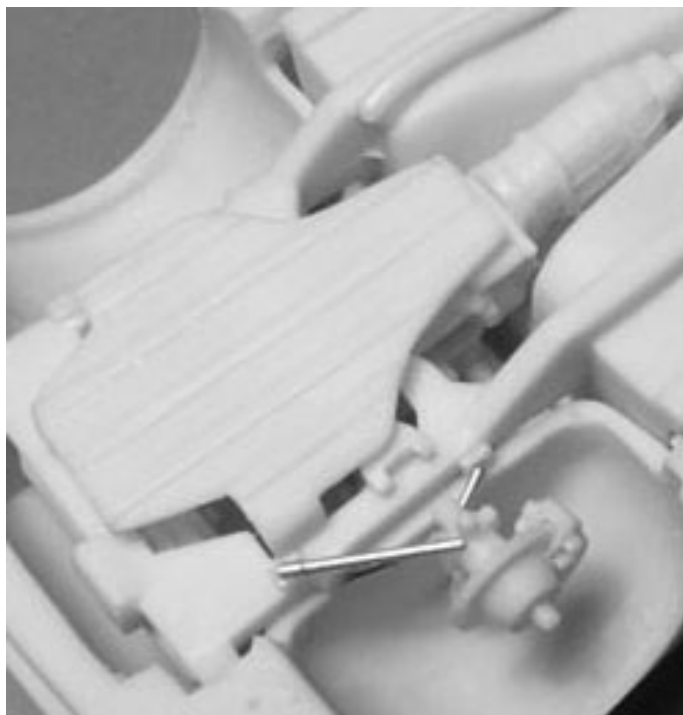
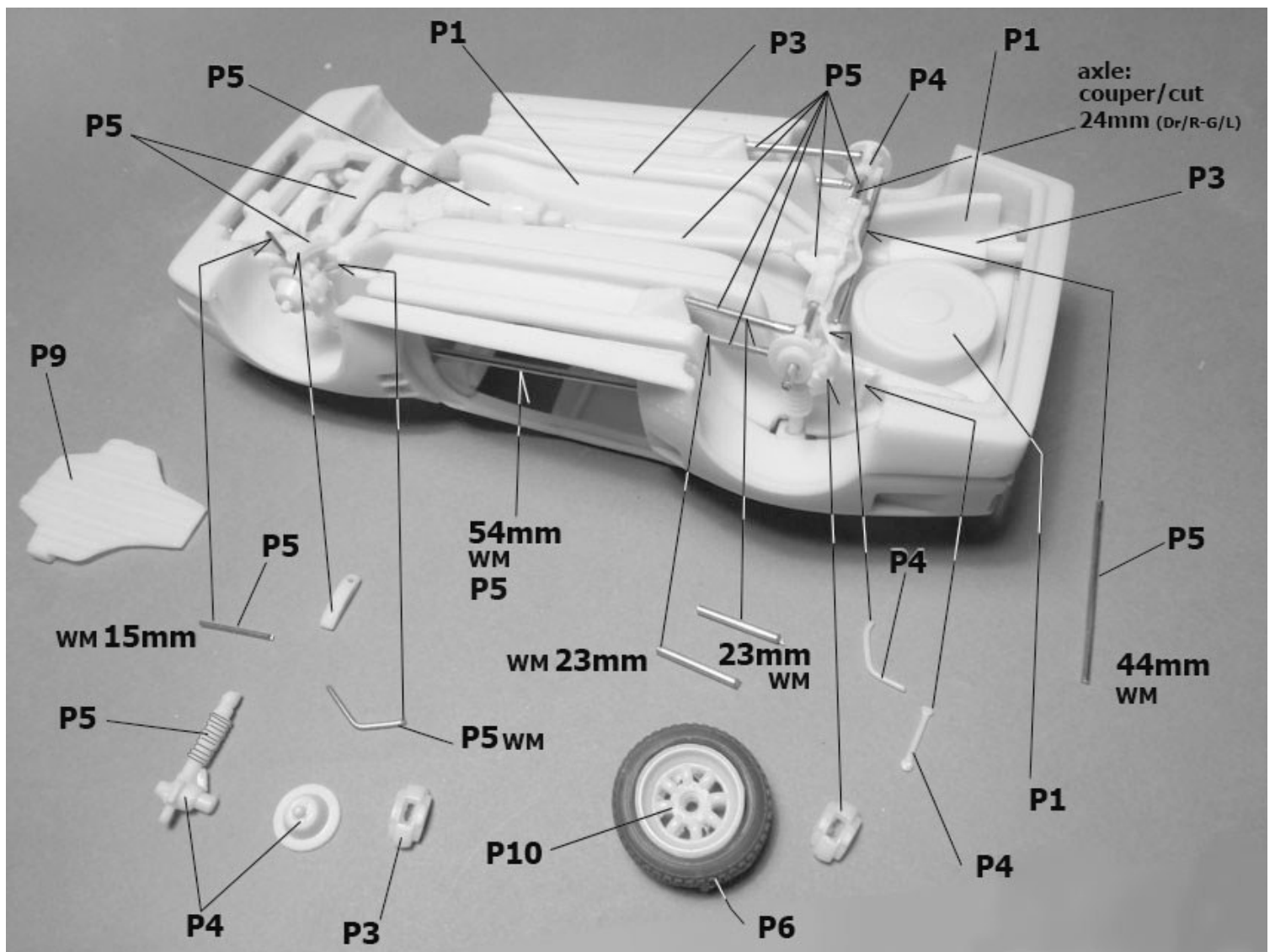

1984



Bjorn Waldegard-Hans Thorzelius
K.UM 210

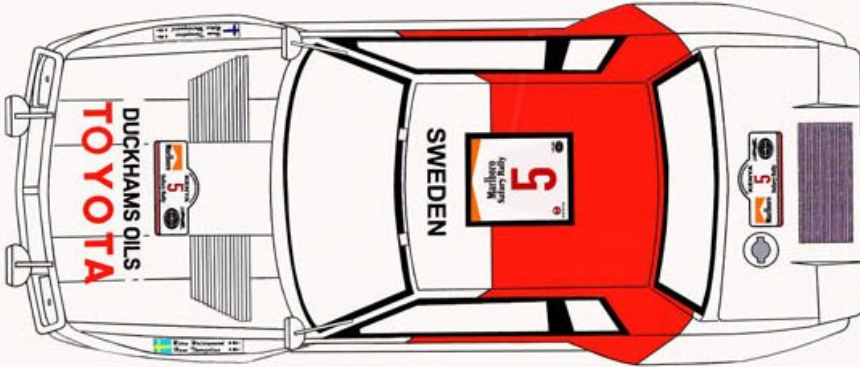

1985/86

1985/86

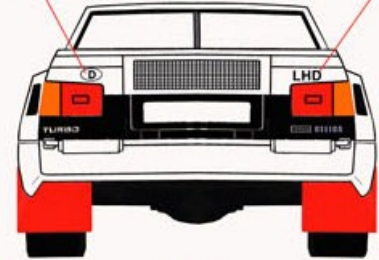

K:UM 210

K:AM 3736

K:AM 418

1984

1985

1986

1985



Juha Kankkunen-Fred Gallagher
K.AM 3736



1986

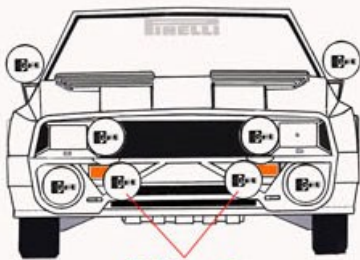

1986 only



Bjon Waldegard-Fred Gallagher
K.AM 418

K:UM 210

K:AM 3736

K:AM 418

1984

1985

1986